



---

Instruction manual

---

RING COMPRESSOR  
VFZ-7W (5W) Standard Model Series  
VFC805A-7(5)WS

---



**WARNING**

- Read the instruction manual carefully before you install, put into operation and maintain the Ring Compressor and handle it properly.
- For the sake of safety, never modify the Ring Compressor.  
We take no responsibility for the troubles caused by repairing or modifying the product.
- Hand over this instruction manual surely to the end users, who actually install, operate and maintain the Ring Compressor.
- After having read the instruction manual, keep it at the place, where can be accessed by the persons, who use it.
- The specification of the product may be changed without prior notification.



# Contents

	Page
<b>CONTENTS.....</b>	<b>- 1 -</b>
<b>1. INTRODUCTION.....</b>	<b>- 2 -</b>
<b>2. WARNINGS FOR SAFETY.....</b>	<b>- 2 -</b>
<b>3. PACKAGE OPENING AND PRODUCT VERIFICATION .....</b>	<b>- 6 -</b>
<b>4. TRANSPORT.....</b>	<b>- 7 -</b>
<b>5. SAFEKEEPING .....</b>	<b>- 7 -</b>
<b>6. NAME OF PARTS .....</b>	<b>- 8 -</b>
<b>7. INSTALLATION , PIPING AND WIRING.....</b>	<b>- 8 -</b>
<b>8. OPERATION.....</b>	<b>- 12 -</b>
<b>9. FAULTS AND COUNTERMEASURES .....</b>	<b>- 16 -</b>
<b>10. PARTS LIST AND DISASSEMBLED DRAWINGS .....</b>	<b>- 18 -</b>
<b>11. SPECIFICATION .....</b>	<b>- 22 -</b>
<b>12. MOTOR PROTECTION .....</b>	<b>- 23 -</b>
<b>13. GUARANTEE PERIOD AND SCOPE OF GUARANTEE.....</b>	<b>- 24 -</b>

# 1. Introduction

Thank you for your purchasing of the Ring Compressor.

It is required for the Ring Compressor for give full play to its performance, for preventing troubles from occurring and for continuing its satisfactory operation for a long period not only to maintain and inspect it after putting it into service but also to handle it properly in every stage after its delivery until its actual operation.

This instruction manual illustrates the essential items for handling the Ring Compressor.

If you find any question, please inquire of our special agent, dealer or business office about it.

## 2. Warnings for safety

- Read this instruction manual and the other attached documents carefully before you use (install, transport, maintain, inspect etc.) the Ring Compressor and then use it properly. Acquire first the machine knowledge, safety information and all warning items and use the machine. Keep this instruction manual at the place, where can be accessed by the persons, who use it.
- The ranks for safety items are classified into dangers and warnings and described in this instruction manual.



**Danger**

: those items, for which the possibility of human **DEATH** and **HEAVY INJURY** are feared, if they are mishandles.



**Warning**

: those items, for which hazardous condition may occur and **MEDIUM HAZARD** and **SLIGHT INJURY** are feared and/or material damage are feared, if they are mishandles.

Even those items marked with



**Warning**

may lead to serious results depending upon the situation.

As every item describes serious contents, be sure to keep it always.

Furthermore, the following symbols are applied according to necessity in this instruction manual, so that the essential points of indication can be grasped at a glance.

Symbol	Meaning
	Notification of a general prohibition
	Always connect a protective earthing terminal!
	Take care of an electrical shock!

Symbol	Meaning
	Do not touch!
	Take care of ignition!
	Take care of a high temperature!



# Danger

General	<ul style="list-style-type: none"><li>• The works of transport, installation, piping, wiring, operation, control, maintenance and inspection may only be executed by the experts, who are well skilled of handling the Ring Compressor. Otherwise, an <b>ELECTRIC SHOCK</b>, an <b>INJURY</b> or a <b>FIRE</b> is feared.</li><li>• Hot line works are forbidden. Work always with the power supply switched off. Otherwise, an <b>ELECTRIC SHOCK</b> or a <b>FIRE</b> is feared.</li><li>• Do not use the Ring Compressor in an explosive atmosphere. Otherwise, an <b>INJURY</b> or a <b>FIRE</b> is feared.</li><li>• Incorrect operation may lead to an <b>FIRE</b>, because of the characteristics of the power cable.</li></ul>
Installation, Adjustment	<ul style="list-style-type: none"><li>• Ground the protective earthing terminal surely. Use the wiring of AWG 14(2.1mm<sup>2</sup>) for VFZ 40 to 60 type, the wiring of AWG 12(3.3mm<sup>2</sup>) for VFZ 70 type, the wiring of AWG 10(5.3mm<sup>2</sup>) for VFZ 80 to 90 type, and ground it near the product. Otherwise, an <b>ELECTRIC SHOCK</b> or a <b>FIRE</b> is feared.</li><li>• In the Ring Compressor is used as mounted on a ceiling or a wall, its fall is feared depending on its mounting condition. Observe the catalog or instruction manual for the details of usable range. An <b>INJURY</b> due to a <b>FIRE</b> is feared.</li></ul>
Piping, Wiring	<ul style="list-style-type: none"><li>• Connect it to the power supply cable according to the wiring diagram within terminal box and the instruction manual. An <b>ELECTRIC SHOCK</b> or a <b>FIRE</b> due to incorrect connection is feared.</li><li>• Use it always at the voltage and frequency indicated in the nameplate on its main body. A <b>BURNOUT</b> or a <b>FIRE</b> is feared.</li><li>• Do not bend, stretch or pinch the power supply cable and the lead wire for the Ring Compressor by force. An <b>ELECTRIC SHOCK</b> or a <b>FIRE</b> is feared.</li><li>• Restore the cover for terminal box to the original position after completion of every work. Otherwise, an <b>ELECTRIC SHOCK</b> is feared.</li></ul>
Operation	<ul style="list-style-type: none"><li>• Never access or touch any rotating body (cooling fan etc.) during running. A <b>CATCH-IN</b> on an <b>INJURY</b> is feared.</li><li>• Switch off the power supply always in case of power failure. An <b>INJURY</b> is feared due to sudden work of the machine at restoration of power supply.</li><li>• Switch off the power supply always when the Ring Compressor is stopped because the protection unit belonging to it worked. An <b>INJURY</b> is feared due to sudden work of Ring Compressor at recovery of the protection unit.</li><li>• Do not run the Ring Compressor at the frequency exceeding 60Hz (50Hz* for models dedicated to 50Hz*). Otherwise, it may lead to a <b>BURN</b>, a <b>FIRE</b>, <b>DAMAGE</b>, or an <b>INJURY</b>. ※50 Hz operation is not covered by UL.</li></ul>

# Warning





General	<ul style="list-style-type: none"> <li>• Do not use the Ring Compressor out of the specifications described in the nameplate, catalog and instruction manual. An <b>ELECTRIC SHOCK</b>, an <b>INJURY</b> or <b>DAMAGE</b> is feared.</li> <li>• Do not use the damaged Ring Compressor. An <b>ELECTRIC SHOCK</b>, an <b>INJURY</b> or a <b>FIRE</b> is feared.</li> <li>• Do not insert any foreign material or finger into the opening (opening in fan cover, admission and discharge ports) of Ring Compressor. An <b>ELECTRIC SHOCK</b> an <b>INJURY</b> or <b>DAMAGE</b> is feared.</li> <li>• We take no responsibility for modification by the customer, as they are out of the scope of our responsibility.</li> </ul>
Transportation	<ul style="list-style-type: none"> <li>• Take full care of fall and tumbling down during transportation. An <b>INJURY</b> is feared.</li> <li>• Lift up the Ring Compressor equipped with a hanger bolt always after getting rid of loosening of the hanger bolt. But after mounting the Ring Compressor on a machine, do not lift up the entire machine using the mounted hanger bolt. Verify the mass of motor based in the nameplate, package box, outline drawing, catalog or the like before lifting it and do not lift any more mass than the rated load of lifting tool. The gravity center of the Ring Compressor is located at motor side, therefore, the Ring Compressor inclines to one side during lift-up. Exert tension gradually on the wire and do not lift up suddenly. This lift-up work may only be executed by the qualified workers. Do not stay under the Ring Compressor during the lifting work. An <b>INJURY</b> or <b>FIRE</b> caused by <b>FALL</b> or <b>TUMBLING DOWN</b> is feared for all of these cases.</li> <li>• When lifting the Ring Compressor without a hanger bolt, pay attention to its weight. Do not allow a single person to lift the product heavier than 15kg. Failure to observe this may cause an <b>INJURY</b>.</li> <li>• Ambient temperature should be kept <math>-20^{\circ}\text{C} \sim +50^{\circ}\text{C}</math> during transportation.</li> </ul>
Opening the Package	<ul style="list-style-type: none"> <li>• Open the package after verifying the top and bottom of product. An <b>INJURY</b> is feared.</li> <li>• Open the wooden frame package taking care of the used nails. Wear glove when opening the wooden package. An <b>INJURY</b> is feared.</li> <li>• Verify if the product is just the ordered one. An <b>INJURY</b>, <b>DAMAGE</b> or a <b>FIRE</b> due to use of the incorrect product is feared.</li> <li>• Verify if no part of the product is damaged during transportation and if all fastening parts including bolts and nuts are securely tightened.</li> </ul>
Installation, Adjustment	<ul style="list-style-type: none"> <li>• Never place any inflammable material around the Ring Compressor. A <b>FIRE</b> is feared.</li> <li>• Do not place any obstacle against ventilation around the Ring Compressor. A <b>BURN</b> or a <b>FIRE</b> caused by abnormal heating due to disturbed cooling is feared.</li> <li>• Fasten the foundation bolts surely. Insufficient fastening may cause an <b>INJURY</b> and <b>DAMAGE</b> due to shift of the Ring Compressor.</li> <li>• Never get on or hang on the Ring Compressor. An <b>INJURY</b> is feared.</li> <li>• Ring Compressor shell be always mounted on suitable place in order to see its nameplate easily and do not put any obstacle in front of it. Do not dismount the nameplate.</li> </ul>

# Warning

Piping, Wiring	<ul style="list-style-type: none"> <li>• Construct the piping and wiring according to the technical standard for electrical equipment and the internal wiring provisions. A <b>BURNOUT</b> or a <b>FIRE</b> is feared.</li> <li>• For wiring to the terminal base in terminal box, fasten the terminal screws with a torque of 1.0 to 1.3 N · m. Otherwise, <b>DAMAGE</b> of the terminal box is feared.</li> <li>• For measuring the insulation resistance, do not touch the terminal. An <b>ELECTRIC SHOCK</b> is feared.</li> <li>• No protection unit belongs to the Ring Compressor except for some models. The installing of overcurrent protection unit is obliged based upon the technical standard for electrical equipment. For preventing a <b>FIRE</b> and <b>DAMAGE</b> due to a motor burnout, we recommend to install the protection unit other than overcurrent protection units (including a ground fault interrupter) based upon consulting with us.</li> </ul>
Operation	<ul style="list-style-type: none"> <li>• If any abnormality occurs, stop the operation immediately and switch off the power supply. An <b>ELECTRIC SHOCK</b> an <b>INJURY</b> or a <b>FIRE</b> is feared.</li> <li>• The Ring Compressor becomes considerably hot during its operation. Take care not to touch it by your hand or body. A <b>BURN</b> is feared.</li> <li>• Do not insert your finger or any others material into the opening of Ring Compressor. An <b>ELECTRIC SHOCK</b> an <b>INJURY</b> or <b>FIRE</b> is feared.</li> <li>• Wear stopples during operation to shut the big noise.</li> </ul>
Maintenance , Inspection	<ul style="list-style-type: none"> <li>• Do not touch the terminal for measuring the insulation resistance. An <b>ELECTRIC SHOCK</b> is feared.</li> <li>• The Ring Compressor becomes considerably hot during its operation. Take care not to touch by your finger and body. A <b>BURN</b> is feared.</li> <li>• Take care, if you use a solvent or the like for cleaning the Ring Compressor. A <b>POISONING</b> is feared. Further, the use of thinner or benzene may cause discoloring or exfoliation of coating on the Ring Compressor.</li> </ul>
Disassembly, Repair, Modification	<ul style="list-style-type: none"> <li>• The repair, disassembling and modification shall be executed only by experts. An <b>INJURY</b> due to the edge of Impeller or key groove, an <b>ELECTRIC SHOCK</b> or a <b>FIRE</b> is feared.</li> </ul>
Disposal	<ul style="list-style-type: none"> <li>• Handle the Ring Compressor as a general industrial waste, when it is be disposed.</li> </ul>

### 3. Package Opening and Product Verification

3. 1 When the Ring Compressor has been delivered, verify the following points.

 <h2 style="margin: 0;">Warning</h2>	
	1. Verify the top and the bottom of product and open the package. Otherwise, an <b>INJURY</b> is feared.
	2. Open the wooden frame package taking care of the used nails. Wear glove when opening the wooden package. An <b>INJURY</b> is feared.
	3. Verify if the delivered product is just the ordered one. (Check the output voltage, frequency, model etc. with the description on face plate.) An <b>INJURY</b> , <b>DAMAGE</b> or a <b>FIRE</b> is feared, if an incorrect product is used.
	4. Verify if any part is damaged and if any bolt or nut is loosened during the transport.

3. 2 Location of name plate, warning labels and electric shock warning labels

The figure below shows the locations of name plate, warning labels and electric shock warning labels.

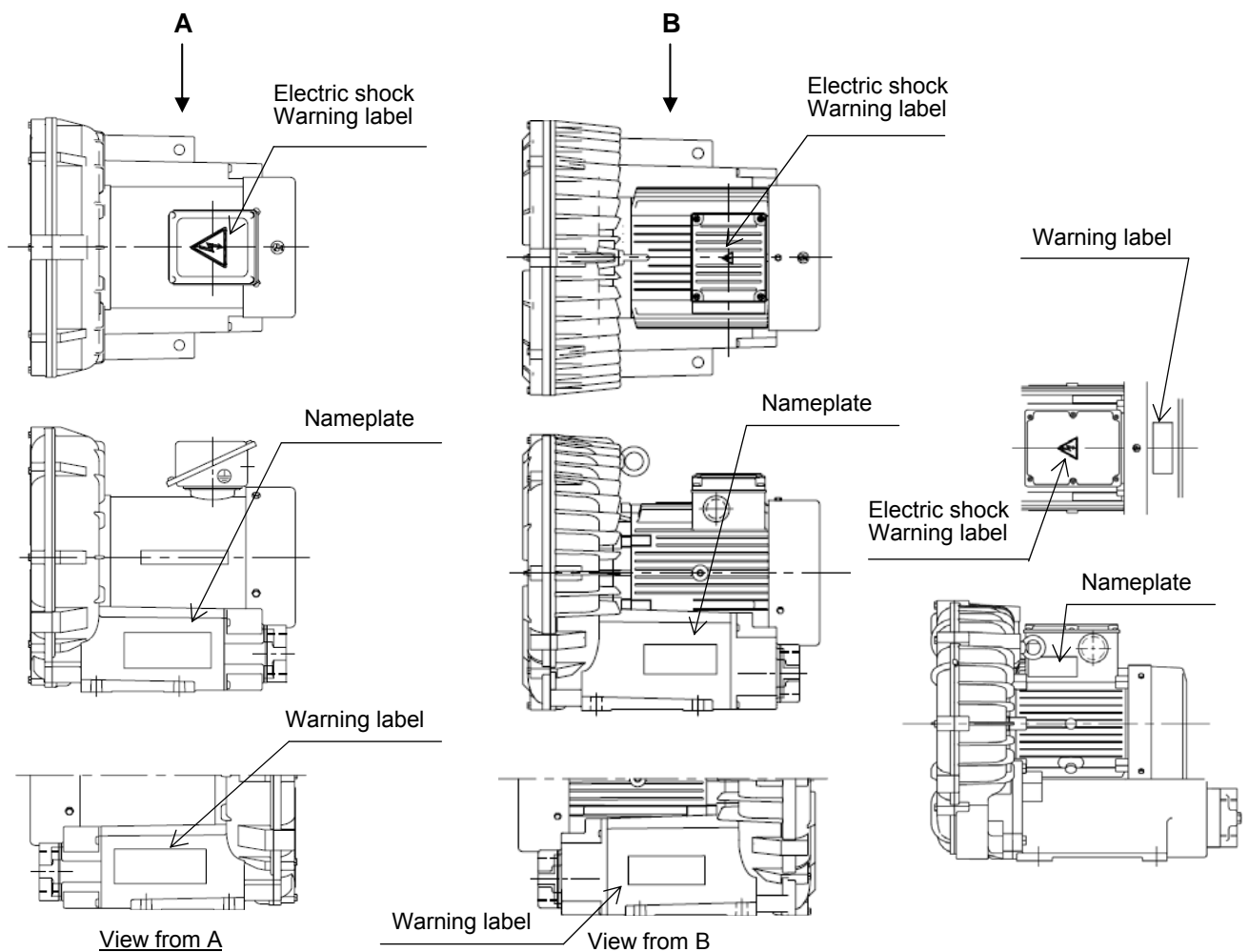

VFZ401~VFZ501A-7W(5W)





VFZ601~701A-7W(5W)

VFZ801~VFZ901A-7W(5W)



## 4. Transport

Take care of the following points for transporting the Ring Compressor.

 <b>Warning</b>	
   	<ol style="list-style-type: none"><li>1. Take full care of fall and tumbling down during transportation. An <b>INJURY</b> is feared.</li><li>2. Lift up the Ring Compressor equipped with a hanger bolt always after getting rid of loosening of the hanger bolt. But after mounting the Ring Compressor on a machine, do not lift up the entire machine using the mounted hanger bolt. Verify the mass of motor based in the nameplate, package box, outline drawing, catalog or the like before lifting it and do not lift any more mass than the rated load of lifting tool. The gravity center of the Ring Compressor is located at motor side, therefore, the Ring Compressor inclines to one side during lift-up. Exert tension gradually on the wire and do not lift up suddenly. This lift-up work may only be executed by the qualified workers. Do not stay under the Ring Compressor during the lifting work. An <b>INJURY</b> or <b>FIRE</b> caused by <b>FALL</b> or <b>TUMBLING DOWN</b> is feared for all of these cases.</li><li>3. When lifting the Ring Compressor without a hanger bolt, pay attention to its weight. Do not allow a single person to lift the product heavier than 15kg. Failure to observe this may cause an <b>INJURY</b>.</li></ol>

### Lifting method of the Ring Compressor

#### 1. Use one hanger bolt

(VFZ501~VFZ701,VFC805)

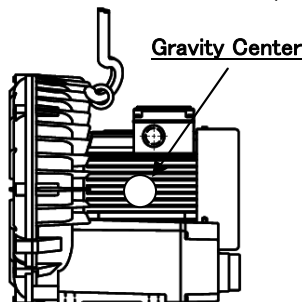

#### 2. Use two hanger bolts

(VFZ801, VFZ901)



#### In case of terminal box is located 45°

(VFZ801, VFZ901)

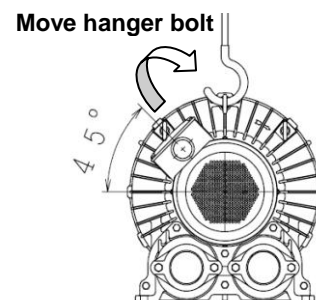

## 5. Safekeeping

Take care of following points for safekeeping the Ring Compressor or suspending its operation for a long period.

### 5.1 For safekeeping in the packed.

Keep the Ring Compressor in an indoor dry place (Ambient temperature: -20°C~+50°C). Do not keep it on such a place, as is exposed to water or dust, or with vibration, or place it on a bare ground directly.

### 5.2 For keeping it in the installed condition.



- (a) Cover the entire Ring Compressor with a sheet for protecting it from invasion of moisture foreign materials.
- (b) Keep the Ring Compressor with its hanger bolt mounted. If it is kept with the hanger bolt dismantled, water may sometimes invade into through the screw hole.
- (c) Run the Ring Compressor for some minutes keeping it and every 3 months, for protecting the bearings from rusting.
- (d) If the operation of Ring Compressor is suspended for a long period, measure the insulation resistance of its winding every 6 months and verify that it is kept at higher than 1 MΩ. If the resistance is not higher than 1 MΩ at normal temperature, such measures are required as to dry the winding.
- (e) Keep the Ring Compressor in an indoor dry place (Ambient temperature: -20°C~+50°C).

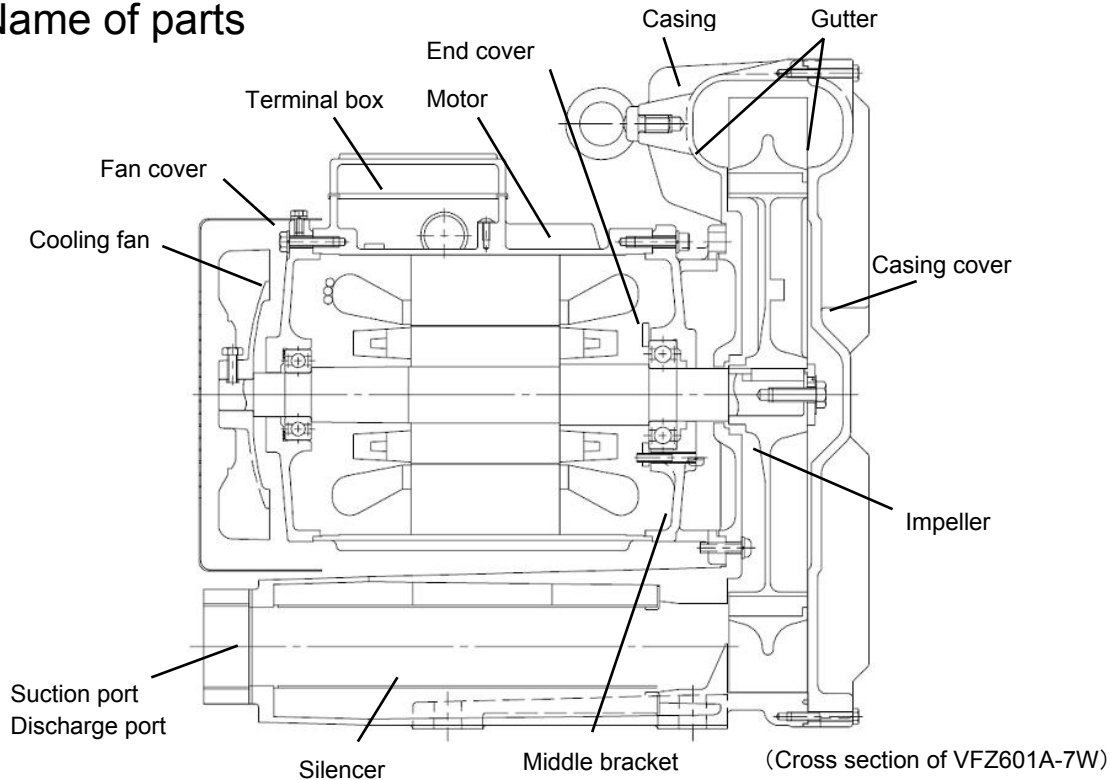





## 6. Name of parts



## 7. Installation , Piping and Wiring

7.1 Take care of the following points for installing and adjusting the Ring Compressor.









 <h3 style="display: inline;">Danger</h3>	
	<p>1. Ground the protective earthing terminal surely. Use the wiring of AWG 14(2.1mm<sup>2</sup>) for VFZ 40 to 60 type, the wiring of AWG 12(3.3mm<sup>2</sup>) for VFZ 70 type, the wiring of AWG 10(5.3mm<sup>2</sup>) for VFZ 80 to 90 type, and ground it near the product. An <b>ELECTRIC SHOCK</b> or a <b>FIRE</b> is feared.</p>
	<p>2. In case of using the Ring Compressor mounted on a ceiling or wall, its fall is feared depending upon the condition. Follow the catalog or instruction manual for details of usable range. <b>INJURY</b> caused by its <b>FALL</b> is feared.</p>

 <h3 style="display: inline;">Warning</h3>	
	<p>3. Never place any inflammable object around the Ring Compressor. A <b>FIRE</b> is feared.</p>
	<p>4. Do not place any obstacle, which disturbs the ventilation, around the Ring Compressor. A <b>BURN</b> or a <b>FIRE</b> caused by abnormal heating is feared, due to the disturbed ventilation.</p>
	<p>5. Fasten the foundation bolts surely before starting the operation. An <b>INJURY</b> or <b>DAMAGE</b> due to shift of the Ring Compressor is feared, if the fastening is insufficient.</p>
	<p>6. Never step on or hang from the Ring Compressor. An <b>INJURY</b> is feared.</p>
	<p>7. Make the nameplate for the Ring Compressor always easily legible and do not place any obstacle in front of it. Do not dismount the face plate.</p>

7.2 Take care of the following ranges for the installation site and the gas to be transported.



## Warning

	1. Outdoor/indoor:	Install at an indoor site, which is exposed to no wind and rain. Otherwise, an <b>ELECTRIC SHOCK</b> or a <b>FAULT</b> is feared.
	2. Ambient temp./ transported gas:	Use it in the range from -10 to 40°C. Otherwise, shortening of life and a <b>FAULT</b> is feared. The transported gas should be standard air. (No freezing is allowed.)
	3. Relative humidity / altitude:	Use relative humidity in 80% or less and 1000m above sea level or less. Shortening of life or <b>FAULT</b> is feared.
	4. Atmosphere / transported gas:	If can neither be used in a place, where any such corrosive liquid or gas as an acid or an alkali or any inflammable or explosive gas exists, nor trans port such material. A <b>FIRE</b> , a <b>FAULT</b> or an <b>INJURY</b> is feared.
	5. Dusts:	Evade a place, where a lot of dusts, wastes or thread chips exist. If inevitable, clean the dusts and wastes adhered in the Ring compressor regularly. A <b>FIRE</b> or a <b>FAULT</b> is feared
	6. Ventilation:	Select a well ventilated place. It shell not be used in a closed room or in a case. A <b>FIRE</b> , a <b>BURN</b> or a <b>FAULT</b> is feared.
	7. Ambient air:	Evade a narrow place, for the convenience of maintenance and inspection.
	8. Vibration:	Select a place, where no external vibration is added to the compressor. If inevitable, take anti-vibration measures for protecting from addition of vibration the Ring compressor. A <b>FAULT</b> , <b>DAMAGE</b> or an <b>INJURY</b> is feared. The value in Figure 1 is recommended as the tolerable vibration value.

Size and tightening torque (recommended value) of the anchor bolt

Anchor hole mm	Bolt size mm	Tightening torque N·m
$\phi$ 12	M10	23.4
$\phi$ 15	M12	41.3
$\phi$ 19	M16	105

※ Bolt materials are recommended values in case of SS, SWRM

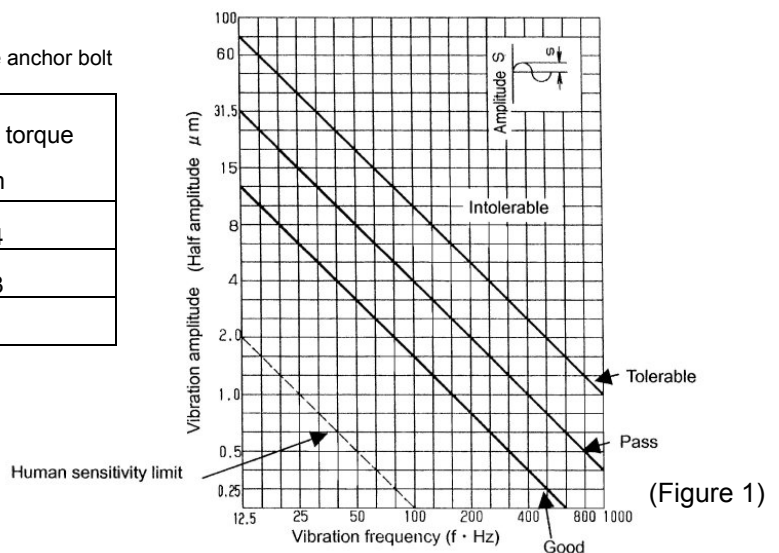



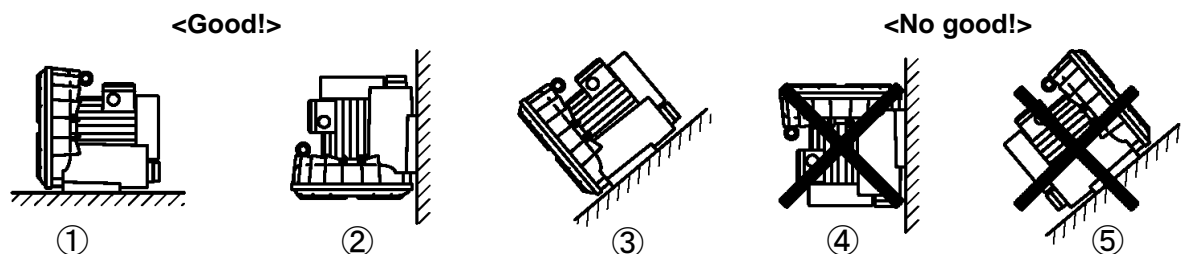

9. Install the Ring Compressor so as to be used in horizontal shaft condition. For installing it in vertical or slant shaft condition, install it so that its compressor side lies under its motor side (Figure 2). ※VFZ701~VFZ901: Horizontal shaft condition only









(Figure 2) - 9 -

10. The tone quality of compressor noise in this product changes depending on the Air flow rate, pressure and fully closed suction operation.

7.3 Observe the following points in piping work and wiring work.

 <b>Danger</b>	
	1. Connect it to the power supply cable according to the wiring diagram within terminal box and the instruction manual. An <b>ELECTRIC SHOCK</b> or a <b>FIRE</b> due to incorrect connection is feared.
	2. Use it always at the voltage and frequency indicated in the nameplate on its main body. A <b>BURNOUT</b> or a <b>FIRE</b> is feared.
	3. Do not bend, stretch or pinch the power supply cable and the lead wire for the Ring Compressor by force. An <b>ELECTRIC SHOCK</b> or a <b>FIRE</b> is feared.
	4. Restore the cover for terminal box to the original position after completion of every work. Otherwise, an <b>ELECTRIC SHOCK</b> is feared.

 <b>Warning</b>	
	5. Ground the protective earthing terminal surely. An <b>ELECTRIC SHOCK</b> or a <b>FIRE</b> is feared.
	6. Construct the piping and wiring according to the technical standard for electrical equipment and the internal wiring provisions. A <b>BURNOUT</b> or a <b>FIRE</b> is feared.
	7. For wiring to the terminal base in terminal box, fasten the terminal screws with a torque of 1.0 to 1.3 N · m. Otherwise, <b>DAMAGE</b> of the terminal box is feared.
	8. For measuring the insulation resistance, do not touch the terminal. An <b>ELECTRIC SHOCK</b> is feared.
	9. No protection unit belongs to the Ring Compressor except for some models. The installing of overcurrent protection unit is obliged based upon the technical standard for electrical equipment. For preventing a <b>FIRE</b> and <b>DAMAGE</b> due to a motor burnout, we recommend to install the protection unit other than overcurrent protection units (including a ground fault interrupter) based upon consulting with us.

10. As the motor load (current) changes depending upon the air flow used by the Ring Compressor, refer to the characteristics curve for setting the wiring capacity and protection relay.

11. Use such pipes as PVC-pipes, gas pipes, flexible hoses etc., which can hold the Ring Compressor pressure and hoses other than metallic one for discharge side, use those once, which have a sufficient high-temperature resistance.

Lay piping so surely as to have no leakage (Figure 3).

**Piping for suction port and discharge port.**

Type for companion flanges

(Type from VFZ40 to VFZ90)

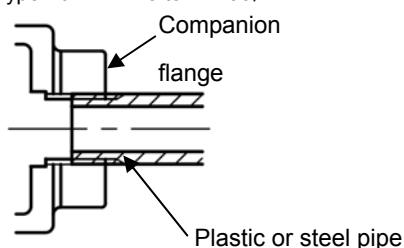

※ In case of piping to companion flanges, companion flanges must be removed from the Ring Compressor before piping, it should be assembled after piping. Take care of the breakage by tightening pipes too much.

(Figure 3)

### Piping for Ring Compressor

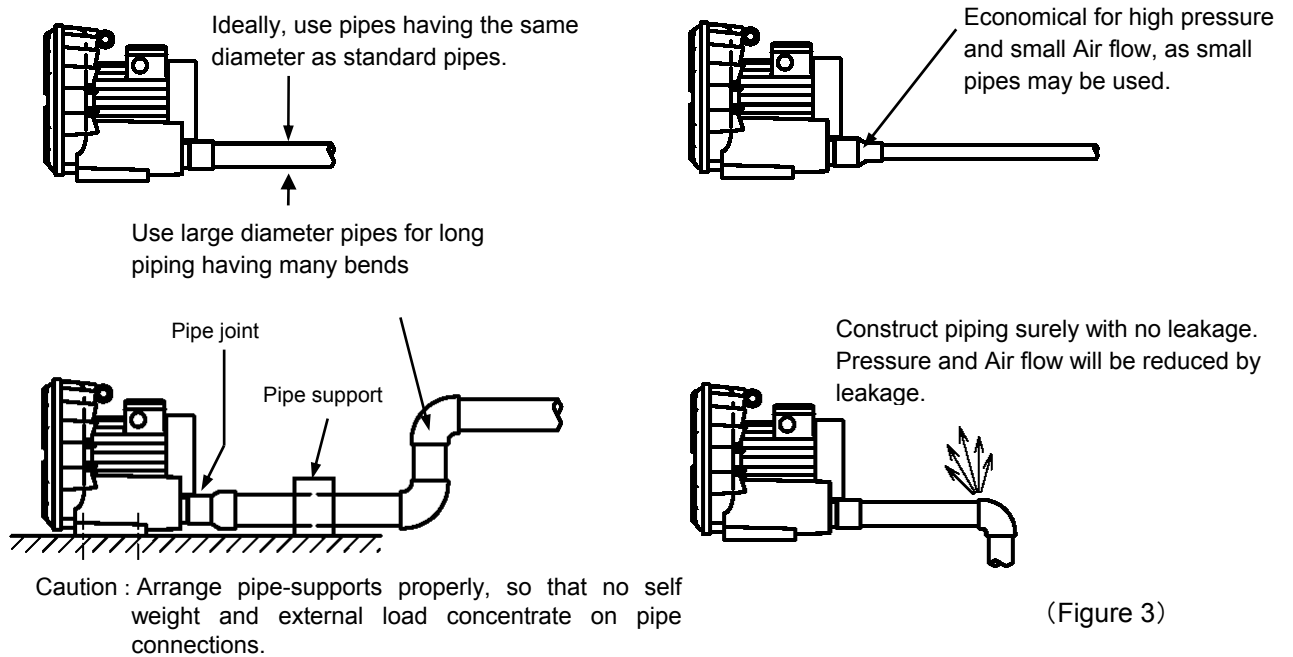

(Figure 3)

12. Do not allow any foreign material to intrude into the compressor.
13. The rotation direction shall be the arrow direction on the casing. The rotation direction can be seen at the shaft end at counter-compressor side and it is also correct, if the wind direction coincides with the IN and OUT indicated at the pipe connection port. Reverse rotation is allowed, although the performance is reduced.
14. Connect the power cables by using gland or electrical conduit at wiring hole of the terminal box to protect dust, foreign objects, water and etc. into the terminal box inside. Do not remove the unused rubber bushes of VFZ501~VFZ901. Do not use the rubber bushes to wiring.
15. Take care of edge of wiring holes at the terminal box. An **INJURY** is feared.

**Recommended gland** VFZ401~VFZ701: Multi hole type seal connector  
VFZ801, VFZ901: Seal connector

16. Wire the power cables with motor terminals surely according to wiring figure in the terminal box or Figure 4.

Model	VFZ401~VFZ601-7W	VFZ701~VFZ901-7W, VFC805A-7WS
Wires	11 wires	11 wires
Connecting method		

(Figure 4) Wiring diagram

Model	VFZ401~VFZ901-5W, VFC805A-5WS
Wires	5 wires
Connecting method	

(Figure 4) Wiring diagram

17. Limit the fluctuations of the supply voltage within  $\pm 10\%$  of the rated voltage, and also limit the fluctuations of the frequency between  $-5\%$  and  $+3\%$  of the rated value. Although you can run the Ring Compressor in these ranges, avoid continuous operation if the voltage is not within  $\pm 5\%$  of the rated value or if the frequency is not within  $\pm 2\%$  of the rated value. Even if the power fluctuations fall within the allowable ranges, the Ring Compressor characteristics and motor characteristics may differ from those at the rated voltage and frequency.

18. Before operating the Ring Compressor, check the following points again.

- Check that the equipment is correctly wired.
- Check that the equipment is securely grounded.
- Check that an appropriate ground fault interrupter and an overload protection device are installed.
- Check that none of the three terminals of the motor has come loose or disconnected.

In case of running the motor with connection of only two terminals, it may cause an open-phase operation, thus leading to motor burnout.

## 8. Operation

Verify the following points for operating the Ring Compressor.

<b>Danger</b>	
	1. Never access or touch the rotating body (cooling fan etc.) during running. <b>CATCH-IN</b> or <b>INJURY</b> is feared.
	2. Turn the power supply switch off in case of power failure. <b>INJURY</b> is feared, when the machine runs suddenly at the power restoration.
	3. Be sure to turn the power supply switch off, in the Ring Compressor has been stopped because the attached protection unit has been activated. An <b>INJURY</b> is feared, as the machine may run suddenly at the power restoration.
	4. Do not run the Ring Compressor at the frequency exceeding 60Hz (50Hz for models dedicated to 50Hz). Otherwise, it may lead to a <b>BURN</b> , a <b>FIRE</b> , <b>DAMAGE</b> , or an <b>INJURY</b> . ※50 Hz operation is not covered by UL.

# Danger



5. If any abnormality occurs, stop the operation immediately and turn the power supply switch off. An **ELECTRIC SHOCK**, an **INJURY** or a **FIRE** is feared.



6. During operation the Ring Compressor, it becomes considerably hot. Take care not to touch by your hand or body. A **BURN** is feared.



7. During its operation, do not insert your finger or any other object into the opening (fan cover, admission and discharge ports etc.) of the Ring Compressor. An **ELECTRIC SHOCK**, an **INJURY** or a **FIRE** is feared.



8. If the Ring Compressor (VFZ401A and larger) is operated with the discharge side closed, the motor and compressor temperature rises drastically and its distortion or damage after long time operation is feared.



9. If the Ring Compressor is operated at a wind flow rate not more than continuous operation range, the motor and compressor temperature rises drastically and its distortion or damage is feared, if the operation is continued for along time.



10. The temperature of the air passing through the Ring Compressor rises. Especially it reaches a high temperature at a nearly closed condition. Take care not to touch it by your hand or body. A **BURN** is feared. Figure 7 shows the temperature rise. Figure 8 shows the high temperature part of the Ring Compressor.



11. During its operation, the Ring Compressor and discharged air will reach a considerably high temperature. Do not use it in a narrow closed room. A **BURN**, a **FIRE** or **DAMAGE** is feared. (Inquire of us, if you use it in closed operation.)

12. The Ring Compressor will be continuously at within the operation range shown on the wind flow rate to static pressure curve (shown in the catalog). This operation range is so wide that the machine can be operated at nearly closed pressure but, if you operate it at high pressure, especially take care not to exceed the operation range. If you must operate it at closed condition, arrange a bypass hole on the way, so that a more wind than required range flows through the compressor even if the suction port is closes (Figure 5).

For using discharge side closed

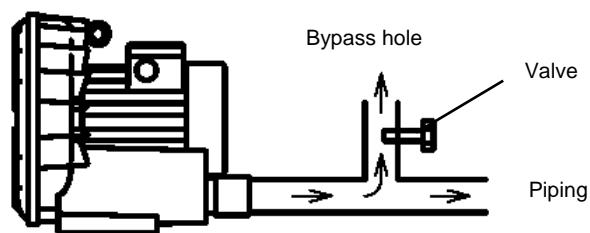

(Figure 5)

13. For using air intermittently, the switching by means of a valve is recommended rather than the switching on and off of the motor (Figure 6). The standard for start and stop frequency of Ring Compressor shall be not higher than the values in table.

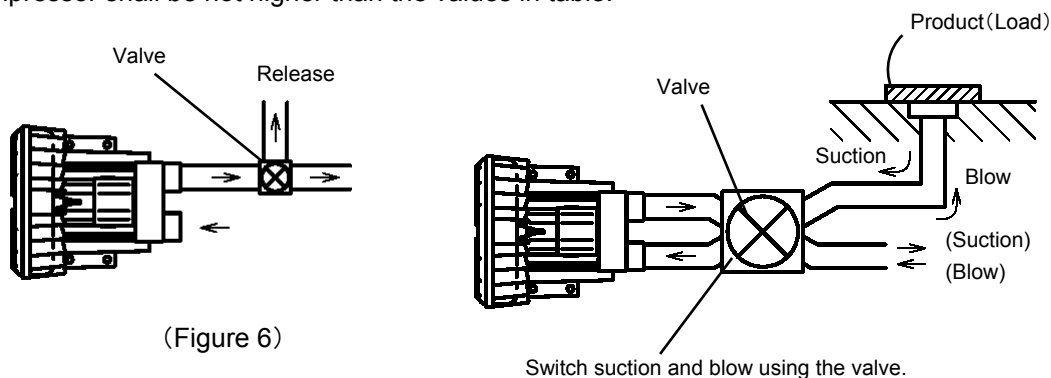

Tolerable start/stop frequency for Ring Compressor [Sw/Hr]

Model	Value for frequency of 50/60Hz
VFZ401 – VFZ601	20/15
VFZ701 – VFZ901	15/10

\*1 switch: one cycle of ON and OFF

\*2 50 Hz operation is not covered by UL.

14. Connect the power cables by using gland or electrical conduit at wiring hole of the terminal box to protect dust, foreign objects, water and etc. into the terminal box inside. Do not remove the unused rubber bushes of VFZ501~VFZ901. Do not use the rubber bushes to wiring.
15. Remove any solid object, dust, thread chip, water drop or the like before entering into the Ring Compressor. Even if make no dust be sucked directly, take measures not to suck any dust staying around by mistake. Use of the dust staying around by mistake. Use of the dust collection sack in a vacuum cleaner or the like is recommended. Also, it is recommended to use a filter having considerably large space. Remove sometimes the dust collected in the filter. It may also be possible to make the dust blow off by reversing the Ring Compressor, if it is possible.
16. If dusts adhered inside and outside of the compressor (especially in the cooling air path for cooling fan cover), remove them. If adhered dusts increase, it causes such troubles as a temperature rise, a sink of wind flow rate and an increase vibration.
17. As the motor load (current) changes depending upon the air flow used by the Ring Compressor, refer to the characteristics curve for setting the wiring capacity and protection relay.
18. The bearing and silencer are consumables and need to be changed when their lives are arrived. Depending on the environment, in which the machine was used, the Impeller, casing, casing cover, and wire net are also included in consumables. (Please notice discharge and suction material is different from VFZ50's and VFZ60's silencers when you exchange them.)

Intervals for inspection and exchange of consumables

Part name	Inspection/exchange interval
Bearing	2 years
Silencer	2 years

\*Standard for use in a standard environment.

They may be shorter depending on the environment.



Table of bearing

Model	Bearing		Grease
	Load side	No-load side	
VFZ401	6204ZZCM	6203ZZCM	Urea
VFZ501	6206ZZC3	6205ZZCM	Urea
VFZ601	6206ZZC3	6205ZZCM	Urea
VFZ701	6306ZZC3	6206ZZCM	Urea
VFZ801	6308ZZC3	6207ZZCM	Urea
VFZ901	6308ZZC3	6306ZZCM	Urea

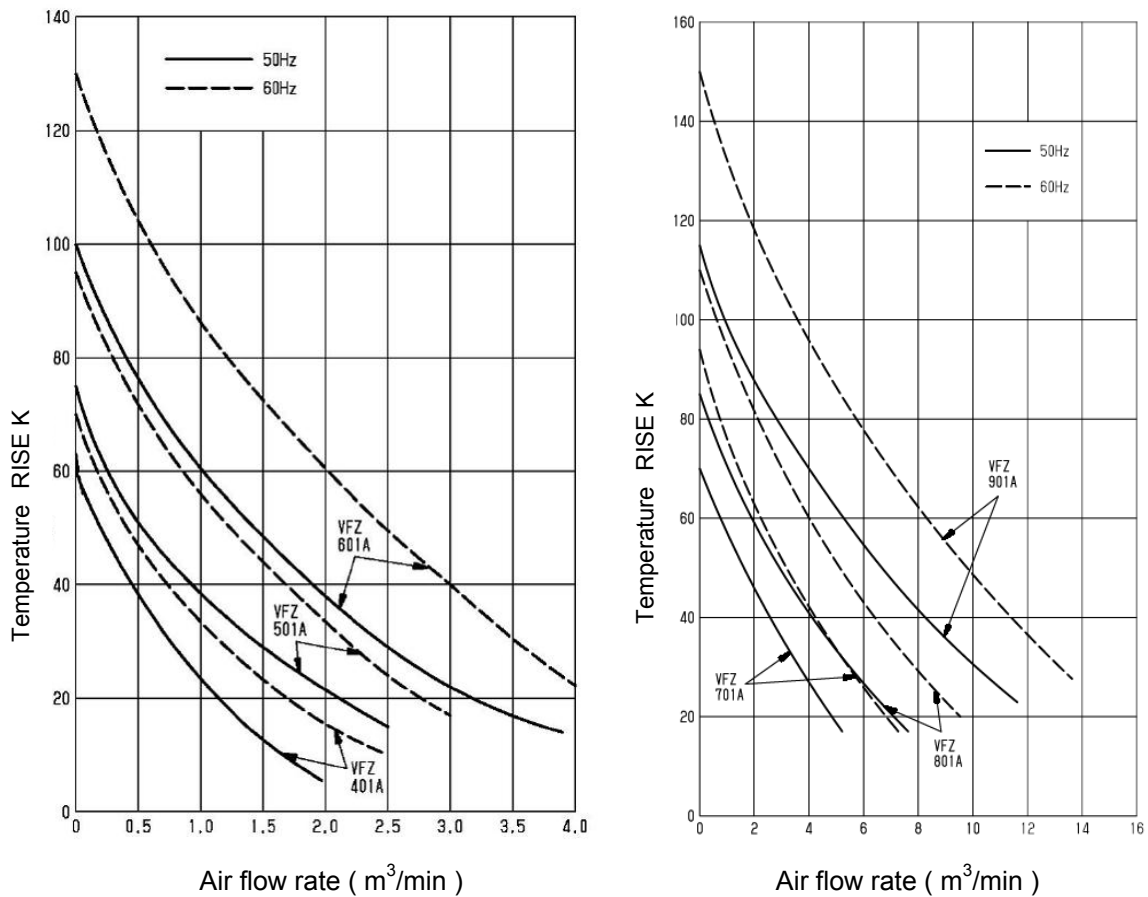

(Figure 7) Discharged air-temperature rise curve

※50 Hz operation is not covered by UL.

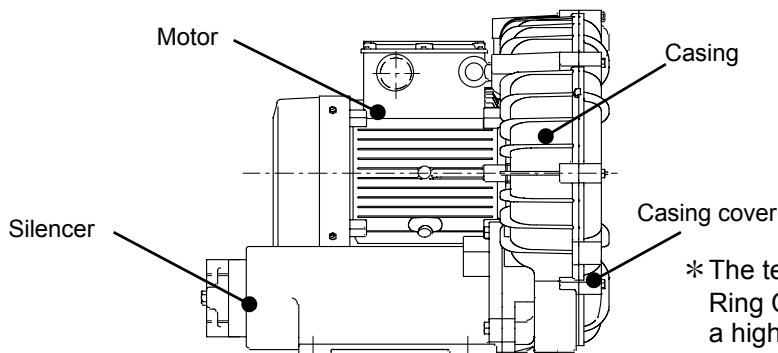

\* The temperature of the air passing through the Ring Compressor rises. Especially it reaches a high temperature at a nearly closed condition.

(Figure 8) High temperature part of the Ring Compressor

19. Confirm below items at test running, if inverter is applied for the Ring Compressor operation.

- Resonance is feared by install condition of the Ring Compressor. Avoid the frequency of the resonance
- Vibration and noise become bigger by using inverter. Stop the operation immediately, if abnormal temperature rise or vibration occurs.
- Do not run the Ring Compressor at the frequency exceeding 60Hz (50 Hz\* for models dedicated to 50 Hz\*). ※50 Hz operation is not covered by UL.

Otherwise, the motor may burn out, or the main body of the compressor may be damaged.

- For the frequency of the startups and shutdowns in the operation with a inverter, refer to the table below.

Tolerable start/stop frequency for Ring Compressor [Sw/Hr]



Model	Value for frequency of 50/60Hz
VFZ401 – VFZ601	20/15
VFZ701 – VFZ901	15/10

\*1 switch: one cycle of ON and OFF

\*2 50 Hz operation is not covered by UL.

## 9. Faults and Countermeasures

In case of occurrence of any fault in the Ring Compressor, handle it properly referring to Table 1 “Fault States of Ring Compressor and Countermeasures” (page 17) and taking care of the following points.

 <h1 style="margin: 0;">Warning</h1>	
 	<ol style="list-style-type: none"> <li>1. Always only the expert shall investigate, repair, disassemble and modify the fault. An <b>INJURY</b> due to the Impeller edge or key groove, an <b>ELECTRIC SHOCK</b> or a <b>FIRE</b> is feared.</li> <li>2. If the Ring Compressor must be abandoned as the result of investigation in a rare possibility, dispose it as a general industrial waste.</li> </ol>

3. If the investigation result shows that the machine cannot be easily repaired, if you will request any spare part or you have any trouble, contact our agent, dealer or business office at any time. In case of contacting us, please verify following items in advance:
  - (a) Model indicated in the nameplate,
  - (b) SER. No.,
  - (c) Details of the fault,
  - (d) Name of faulty part, name of spare parts,
  - (e) Required quantity and
  - (f) Kind of gas to be transported (e.g. Air)

Table - 1 Fault States of Ring Compressor and Countermeasures

States of Fault		Causes	Countermeasures
Does not rotate	Whining sound	Switch-contact fault	Repair switch-contact.
		Fuse blown	Replace it.
		One phase of power supply connection wires disconnected.	Replace it.
		One phase of stator coils disconnected.	Request factory to repair it.
		Stator and rotor come into contact due to bearing fault.	Replace bearing.
		Foreign material involved in blades.	Remove it.
	No sound	Power failure	Consult with utility company.
		2 phases of power supply connection wires disconnected.	Replace them.
		2 phases of stator coils disconnected.	Request factory to repair them.
		Switch fault	Replace or replace it.
Rotates	Fuse blown	Short-circuit in circuit	Repair or replace it.
	Motor overheated	Power supply voltage fell	Consult with utility company.
		Single phase operation	Request factory to repair it.
		Impeller rubbing	Adjust wheel.
	Whining sound	1 phase short circuit in stator coils.	Request factory to repair it.
		Uneven space between stator and rotor.	Request factory to repair it.
	Abnormal noise	Blade wheel rubbing	Adjust it.
		Blade damaged due to foreign material.	Request factory to repair it.
		Bearing fault	Replace it.
	Motor rotates but fan works improperly.	Leakage in piping.	Fasten tightly.
		Piping blocked	Ventilate sufficiently.
		Reverse rotation direction	Correct connection (2 out of 3 wires).
		Closure equipment fault	Replace it.

## 10. Parts List and Disassembled Drawings

The Parts List of Ring Compressor is shown below.

The Parts No. in Parts List corresponds to those in Disassembled Drawings.

Caution: Some parts are not used for some machine models.

Part No.	Name of Part	Part No.	Name of Part	Part No.	Name of Part
1-1	Casing cover	3-4	Bearing at counter-driving side	4-28	Cap
1-2	Bolt (for Casing cover)	3-5	Bearing at driving side	5-1	Terminal box
1-3	Impeller	3-6	Spacer	5-2	Packing (for Terminal box)
2-1	Casing	3-7	Press ring	5-3	Terminal box cover
2-2	Bolt (for Casing)	3-8	Bolt (for fastening Fan wheel)	5-6	Packing (for Terminal box cover)
2-3	Spring washer	3-9	Claw washer	5-7	Bolt (for Terminal box cover)
2-4	End cover	3-11	Key (for Fan Wheel)	5-8	Bush (for Terminal box)
2-5	Bolt (for End cover)	3-12	Motor cooler fan	5-9	Bolt (for Protective earthing terminal)
2-6	Spring washer	3-13	Bolt (for Motor cooler fan)	5-20	Bush (for Leader mouth for Terminal box)
2-7	Silencer (1 set)	4-1	Frame/Stator assembly	5-21	Bolt (for Motor)
2-7-1	Silencer (Suction side)	4-4	Shield at counter-driving side	5-22	Nut (for Motor)
2-7-2	Silencer (Discharge side)	4-5	Waved washer		
2-8	Flange	4-7	Bolt (for Shield)		
2-9	Bolt (for Flange)	4-8	Cooler fan cover		
2-10	Filter	4-9	Bolt (for Cooler fan cover)		
2-15	Silencer Retaining Net	4-13	Bolt (Shield, frame)		
2-16	Silencer box	4-14	Nut (Shield, frame)		
2-17	Bolt (for Silencer box)	4-15	Spring washer (Shield, frame)		
2-18	Hanger bolt	4-16	Middle bracket		
2-20	Spring washer (for Silencer box)	4-17	Bolt (Middle bracket, frame)		
3-1	Shaft/Rotor assembly	4-18	Spring washer		

**Disassembled VFZ401A-7W(5W) – VFZ501A-7W(5W)**

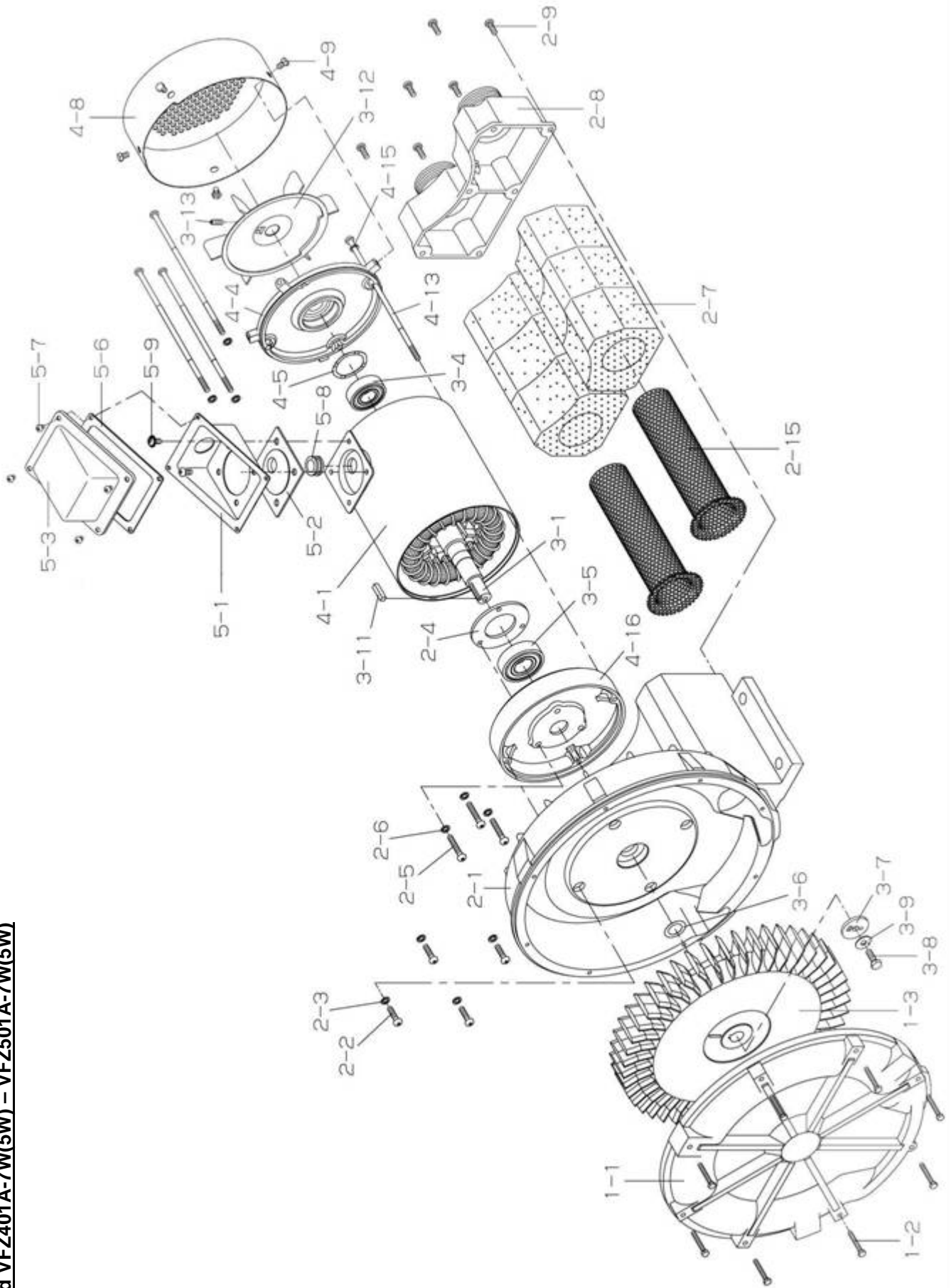

**Disassembled VFZ601A-7W(5W)**

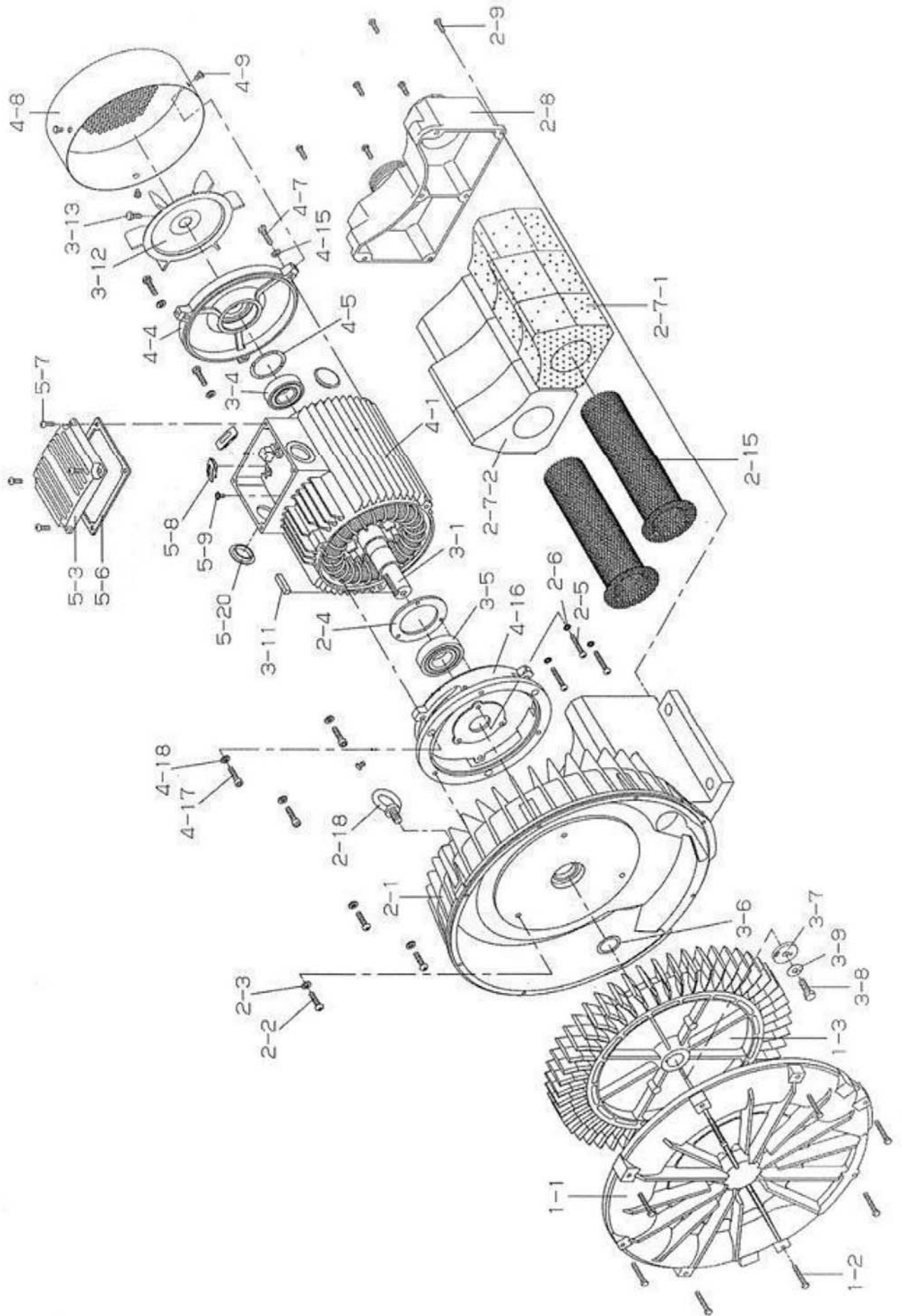

Disassembled VFZ701A-7W(5W)~VFZ901A-7W(5W)

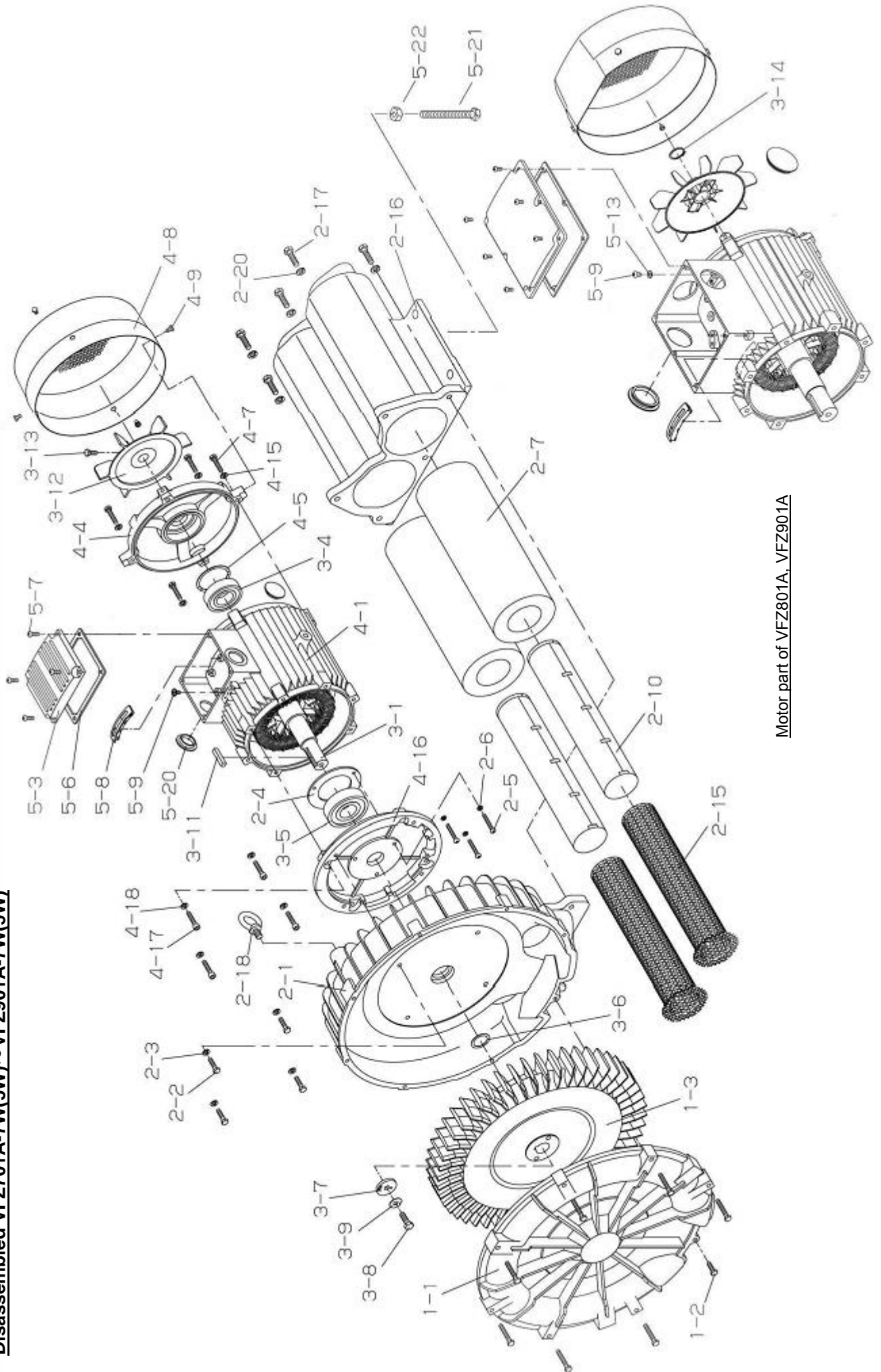

Motor part of VFZ801A, VFZ901A

# 11. Specification

Model	Voltage [V]	Frequency [Hz]	Delivery character												
			Output(*)		Current(*) [A]	Maximum value				Rated value				Minimum air quantity	
						Pressure(*)		Air quantity(*)		Static pressure		Static air quantity			
			[HP]	[kW]	[in.H <sub>2</sub> O]	[kPa]	[SCFM]	[m <sup>3</sup> /min]	[in.H <sub>2</sub> O]	[kPa]	[SCFM]	[m <sup>3</sup> /min]	[SCFM]	[m <sup>3</sup> /min]	
VFZ401A-7W	3 φ 208-230/ 460	60	1.3	0.95	3.8-3.5/1.8	60	15.3	89	2.6	19	4.90	68	1.95	7	0.2
VFZ501A-7W			2.7	2	7.8-7.4/3.7	80	20.3	135	3.9	27	6.86	104	3	45	1.3
VFZ601A-7W			5	3.7	13.2-12.1/6.1	112	28.5	173	5	39	9.81	153	4.4	56	1.6
VFZ701A-7W			6.7	5	17.6-16.2/8.1	105	26.7	217	6.3	39	9.81	198	5.7	87	2.5
VFZ801A-7W			11	8	27.8-25.2/12.6	115	29.2	379	10.9	39	9.81	295	8.5	132	3.8
VFC805A-7WS			11	8	27.8-25.2/12.6	115	29.2	379	10.9	39	9.81	295	8.5	132	3.8
VFZ901A-7W			15	11	39.1-37.8/18.9	90-94/104	23.0-24.0/26.5	574	16.5	58	14.7	375	10.8	191	5.5
VFZ401A-5W	3 φ 575	60	1.3	0.95	1.4	60	15.3	89	2.6	19	4.90	68	1.95	7	0.2
VFZ501A-5W			2.7	2	3.0	80	20.3	135	3.9	27	6.86	104	3	45	1.3
VFZ601A-5W			5	3.7	4.9	112	28.5	173	5	39	9.81	153	4.4	56	1.6
VFZ501A-5W			6.7	5	6.5	105	26.7	217	6.3	39	9.81	198	5.7	87	2.5
VFZ801A-5W			11	8	10.1	115	29.2	379	10.9	39	9.81	295	8.5	132	3.8
VFC805A-5WS			11	8	10.1	115	29.2	379	10.9	39	9.81	295	8.5	132	3.8
VFZ901A-5W			15	11	15.2	100	25.4	574	16.5	58	14.7	375	10.8	191	5.5

Model	Suction character								Insulation class	Noise value [dB(A)]	Suction/delivery bore diameter	Starting current [A]	Approximate mass	
	Output		Current [A]	Pressure		Minimum air quantity		[kg]					[lbs]	
	[HP]	[kW]		[in.H <sub>2</sub> O]	[kPa]	[SCFM]	[m <sup>3</sup> /min]							
VFZ401A-7W	1.1	0.85	3.3-3.2/1.6	53	12.9	0	0	F	69.5	NPSC 1 1/2	33.3-36.0/18.0	21.0	46	
VFZ501A-7W	2.4	1.8	6.9-6.7/3.4	82	20.8	0	0	F	74.5	NPSC 1 1/2	69-76/38	35.0	77	
VFZ601A-7W	4.4	3.3	11.2-10.8/5.4	95	23.6	0	0	F	74.5	NPSC 2	119-132/66	49.0	108	
VFZ701A-7W	6.4	4.8	16.2-15.3/7.7	99	25.1	0	0	F	79.5	NPSC 2	189-210/105	61.0	134	
VFZ801A-7W	10.4	7.8	23.0-22.1/11.0	108	26.6	0	0	F	81	NPSC 2 1/2	252-270/135	95.5	211	
VFC805A-7WS	10.4	7.8	23.0-22.1/11.0	108	26.6	0	0	F	81	NPSC 2 1/2	252-270/135	130.0	287	
VFZ901A-7W	13.7	10.3	33.9-33.7/17.0	85	21.5	146	4.2	F	83	NPSC 3	456-500/250	117.5	259	
VFZ401A-5W	0.85	0.85	1.2	53	12.9	0	0	F	69.5	NPSC 1 1/2	28.8	21.0	46	
VFZ501A-5W	1.8	1.8	2.7	82	20.8	0	0	F	74.5	NPSC 1 1/2	30	35.0	77	
VFZ601A-5W	3.3	3.3	4.2	95	23.6	0	0	F	74.5	NPSC 2	53	49.0	108	
VFZ501A-5W	4.8	4.8	6.0	99	25.1	0	0	F	79.5	NPSC 2	84	61.0	134	
VFZ801A-5W	7.8	7.8	8.4	108	26.6	0	0	F	81	NPSC 2 1/2	108	95.5	211	
VFC805A-5WS	7.8	7.8	8.4	108	26.6	0	0	F	81	NPSC 2 1/2	108	130.0	287	
VFZ901A-5W	10.3	10.3	13.2	85	21.5	146	4.2	F	83	NPSC 3	200	117.5	259	

The noise is the value at a position of 1.5m in an open state.

The values with (\*)mark are specified on nameplate.

The maximum static pressure of the delivery character is the value near the discharge port, and it is the value of the state where the temperature is saturated.

Model	Voltage [V]	Frequency [Hz]	Delivery character								
			Output		Current [A]	Pressure		Air quantity		Minimum air quantity	
			[HP]	[kW]		[in.H <sub>2</sub> O]	[kPa]	[SCFM]	[m <sup>3</sup> /min]	[SCFM]	[m <sup>3</sup> /min]
VFZ401A-7W	3 φ 200/400	50 <sup>(※)</sup>	0.8	0.6	3.0/1.5	42	10.4	74	2	0	0
VFZ501A-7W			1.9	1.4	6.5/3.8	60	14.7	114	3.4	7	0.2
VFZ601A-7W			3.6	2.7	10.6/5.3	85	21.6	145	4.2	28	0.8
VFZ701A-7W			4.4	3.3	13.4/6.7	84	21.4	179	5.2	38	1.1
VFZ801A-7W			7.3	5.5	20.5/10.3	85	21.6	318	8.7	63	1.8
VFC805A-7WS			7.3	5.5	20.5/10.3	85	21.6	318	8.7	63	1.8
VFZ901A-7W			9.3	7.0	39.7/19.9	78	19.8	472	13	90	2.6

Model	Suction character								Insulation class	Noise value [dB(A)]	Suction/delivery bore diameter	Starting current [A]	Approximate mass	
	Output		Current [A]	Pressure		Minimum air quantity		[kg]					[lbs]	
	[HP]	[kW]		[in.H <sub>2</sub> O]	[kPa]	[SCFM]	[m <sup>3</sup> /min]							
VFZ401A-7W	0.71	0.53	2.7/1.3	39	9.4	0	0	F	65.5	NPSC 1 1/2	32.5/16.3	21.0	46	
VFZ501A-7W	1.7	1.3	6.0/3.0	55	13.7	0	0	F	70.5	NPSC 1 1/2	71/35.5	35.0	77	
VFZ601A-7W	3.1	2.3	9.8/4.9	72	18.2	0	0	F	70.0	NPSC 2	120/60	49.0	108	
VFZ701A-7W	4.1	3.1	12.7/6.3	78	18.3	0	0	F	75.0	NPSC 2	195/97.5	61.0	134	
VFZ801A-7W	6.9	5.2	18.8/9.4	88	21.6	0	0	F	78.0	NPSC 2 1/2	268/134	95.5	211	
VFC805A-7WS	6.9	5.2	18.8/9.4	88	21.6	0	0	F	78.0	NPSC 2 1/2	268/134	130.0	287	
VFZ901A-7W	9.3	7	24.5/12.2	63	19.7	111	3.2	F	79.5	NPSC 3	438/219	117.5	259	

The noise is the value at a position of 1.5m in an open state.

(※) 50 Hz operation is not covered by UL.



## 12. Motor Protection

The overload will cause the protector (MMS) to operate. Please set the protector (MMS) with setting current. UL evaluation test was carried out at the protector (MMS). Protector circuits other than MMS are listed as recommended. Please judge the use on the final product side.(Figure 9)

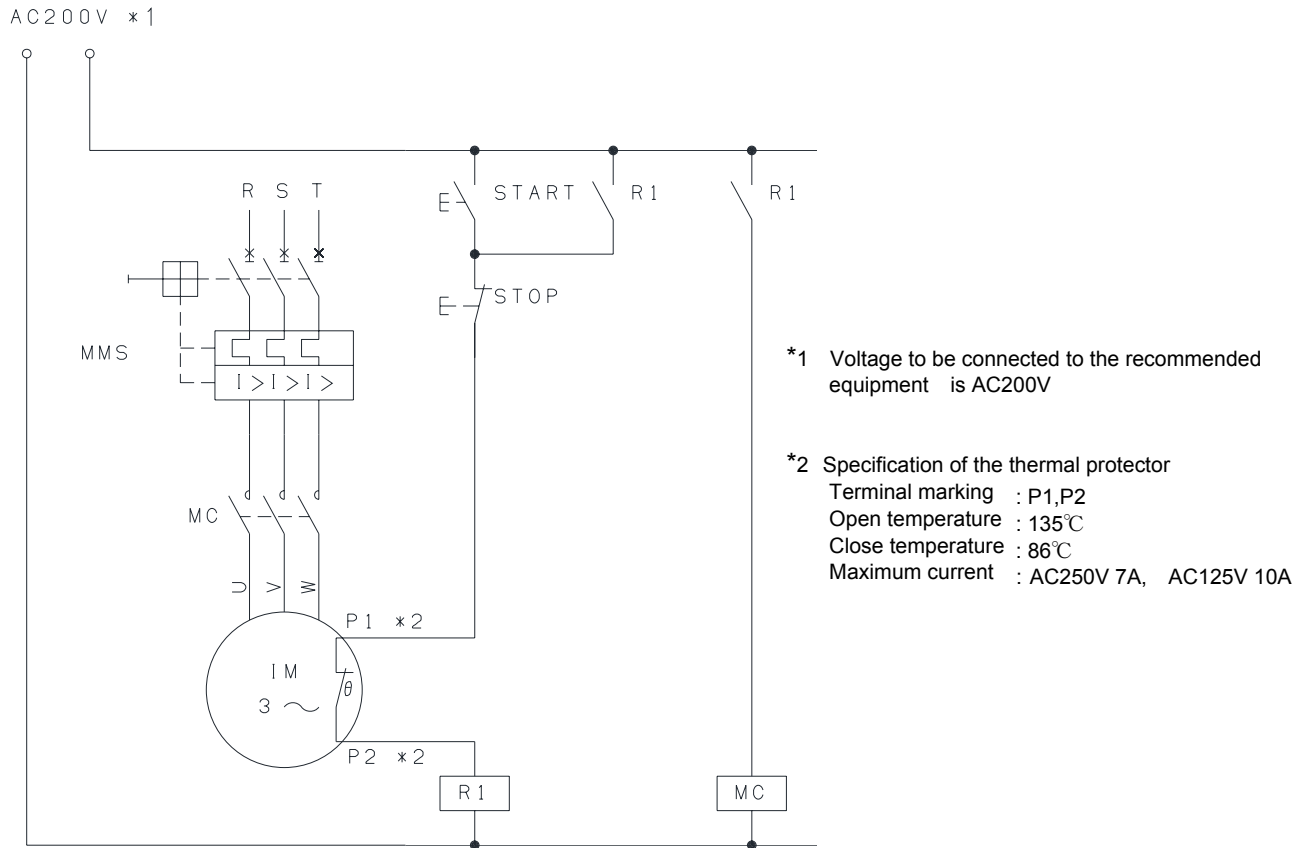

Recommended Equipment *3												
Blower		Motor Controllers, Manual *4			Magnetic Contactors			Electromagnetic Relay		Push button switches		
Model	Voltage(V)	Model	Setting current	File No.	Model	Specification	File No.	Model	Specification	File No.	Model	File No.
VFZ401A-7W	208	BM3RSB-6P3	4A	E163944	SC-03	200V 7.8A	E42419	HH52	200V	E42419	AR22	E44592(UL) LR20479(CSA)
	230	BM3RSB-6P3	4A		SC-03	200V 7.8A						
	460	BM3RSB-2P5	2A		SC-03	200V 7.8A						
VFZ501A-7W	208	BM3RSB-010	8A		SC-0	200V 11A						
	230	BM3RSB-010	8A		SC-0	200V 11A						
	460	BM3RSB-004	4A		SC-03	200V 7.8A						
VFZ601A-7W	208	BM3RSB-016	14A		SC-4-0	200V 17.5A						
	230	BM3RSB-016	14A		SC-4-0	200V 17.5A						
	460	BM3RSB-010	7A		SC-03	200V 7.8A						
VFZ701A-7W	208	BM3RSB-025	21A		SC-N1	200V 25.3A						
	230	BM3RSB-025	22A		SC-N1	200V 25.3A						
	460	BM3RSB-013	11A		SC-4-0	200V 17.5A						
VFZ801A-7W	208	BM3VSB-050	28A		SC-N2	200V 32.2A						
	230	BM3VSB-050	30A		SC-N1	200V 25.3A						
	460	BM3RSB-020	14A		SC-4-1	200V 17.5A						
VFC805A-7WS	208	BM3VSB-050	28A		SC-N2	200V 32.2A						
	230	BM3VSB-050	30A		SC-N1	200V 25.3A						
	460	BM3RSB-020	14A		SC-4-1	200V 17.5A						
VFZ901A-7W	208	BM3VSB-063	48A		SC-N2	200V 32.2A						
	230	BM3VSB-063	52A		SC-N2	200V 32.2A						
	460	BM3RSB-032	26A		SC-N1	200V 25.3A						
VFZ401A-5W	575	BM3RSB-2P5	1.6A		SC-03	200V 7.8A						
VFZ501A-5W	575	BM3RSB-004	3.2A		SC-03	200V 7.8A						
VFZ601A-5W	575	BM3RSB-6P3	5.5A		SC-03	200V 7.8A						
VFZ501A-5W	575	BM3RSB-013	9A		SC-4-0	200V 17.5A						
VFZ801A-5W	575	BM3RSB-020	14A		SC-4-1	200V 17.5A						
VFC805A-5WS	575	BM3RSB-020	14A		SC-4-1	200V 17.5A						
VFZ901A-5W	575	BM3RSB-025	21A		SC-N1	200V 25.3A						

\*3 Recommended equipment is a reference model manufactured by Fuji Electric.

\*4 UL evaluation test was carried out at the protector (MMS).

(Figure 9)Recommended protector connection

## 13. Guarantee Period and Scope of Guarantee

### <Product guarantee and scope of guarantee>

- The guarantee period of for product shall be 1.5 years after shipment to the specified destination. If any fault has occurred during the guarantee period in a proper use condition within he product specification range, the faulty part will be exchanged or repaired free of charge.
- However, if the fault corresponds to any of the following cases, it will be excluded from the scope of guarantee:
  - 1) due to improper handling or use by the User
  - 2) due to causes of fault other then of delivered product
  - 3) due to improper repair of modification
  - 4) due to natural calamity or disaster, which does not belong to the responsibility of supplier. The said guarantee means the guarantee for supplied product itself and we take no responsibility for the damage induced from the fault of the product.

### <Charged repair>

- The investigation and repair after the expiration of guarantee period will be charged. Even during the guarantee period, we accept the repair of fault and the cause investigation due to reasons out of the scope of guarantee for payment.

NOTE

---

---

## **Fuji Electric Corp. of America**

50 NORTHFIELD AVENUE, EDISON, NJ08837

PHONE : (510)440-1060      FAX : (510)440-1063

URL <http://www.americas.fujielectric.com/>